

Input Volts	120 HPF	
Circuit Type	Reactor	
Power Factor	>0.9 w/ Cap	
Regulation		
Line Volts	± 5 %	
Lamp Watts		
Line Current (Amps)		
Operating	0.70	
Open Circuit	1.3	
Starting	1.00	
Recommended Fuse	3	
UL Temperature Ratings		
Insulation Class	H (180°C)	
Coil Temperature Code	A	
Benchtop Coil Rise Primary	70	
Input Watts	80	
NOM Open Circuit Volts	120	
Current Crest Factor	1.55	
Input Voltage at Lamp Dropout	60	
Min Ambient Starting Temp.	-40F -40°C	
High Potential Test (Volts)		
1 Minute	1240	
1 Second	1490	
Open Circuit Voltage Test (Volts)		
Open Circuit Voltage	114 - 126	
Input Current	min	1.05
	max	1.60
Short Circuit Current Test (Amps)		
Secondary Current	1.80 - 2.70	
Input Current	min	0.70
	max	1.20
Core and Coil Specifications		
Dimension A"	1.30"	
Dimension B"	2.50"	
Weight (lbs.)	2.1	
Lead Lengths (in)	12	
Capacitor Specifications		
Microfarads	28.0	
Volts (min.)	120	
	Oval OIL Filled	DRY Film
Case Size (in.)	1.22 x 2.04	1.38
Height (in.)	3.94	3.15
Temp Rating °C	90	100
Starter Specifications		
Model Number	ST2001	
BTL	2	
Temp Rating °C	105	

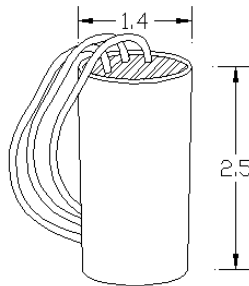
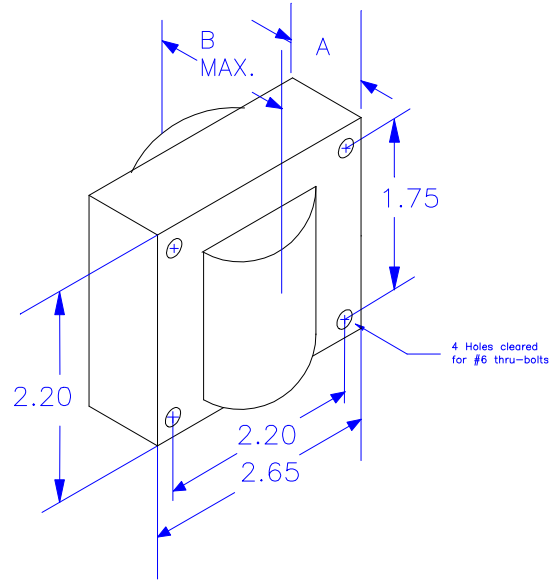
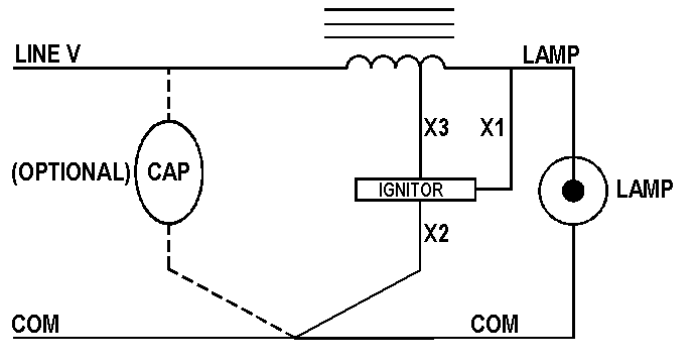

Starter Case Drawing

Rev. Date: 12/8/08

Test Ref.:

Specifications subject to change without notice.

Howard Industries, Inc. Ballast Products Division P.O. Box 1590 Laurel, MS 39441

Phone: 1-800-956-3456

Fax: (601) 422-1652

www.howard-ballast.com